

# the **GENERAL RADIO** Experimenter



Copyright 1955 • GENERAL RADIO Company, Cambridge, Mass., U. S. A.  
 Since 1915 — Manufacturers of Electronic Apparatus for Science and Industry

VOLUME 30 No. 3

AUGUST, 1955

## AN ACCURATE VOLTAGE DIVIDER FOR DC AND AUDIO FREQUENCIES

*JDS file*

### Also IN THIS ISSUE

NEW COAXIAL ELEMENTS.....6

An accurate decade voltage divider is one of the basic tools of the electrical laboratory. Among its many uses are the calibration of voltmeters, linearity measurements on continuously adjustable transformers and resistors, the measurement of gain and attenuation, and the precise measurement of the frequency response characteristics of audio-frequency networks.

The General Radio Company has been manufacturing this type of voltage divider for over 25 years. The latest

model is the TYPE 1454-A Decade Voltage Divider, which has a higher accuracy than its predecessors and since it uses four decades of voltage division, rather than three, it also has a higher resolution. At dc, its accuracy is adequate for many measurements for which the slide-wire potentiometer is commonly used, while its equally good a-c performance extends its field of application to the entire audio-frequency range.

The new Voltage Divider, shown in Figure 1, has a constant input resistance of 10,000 ohms. The method of voltage division, which is attributed to Kelvin and Varley, is shown in the schematic diagram of Figure 2. There are eleven equal resistors comprising the first

Figure 1. Panel view of the Type 1454-A Decade Voltage Divider.

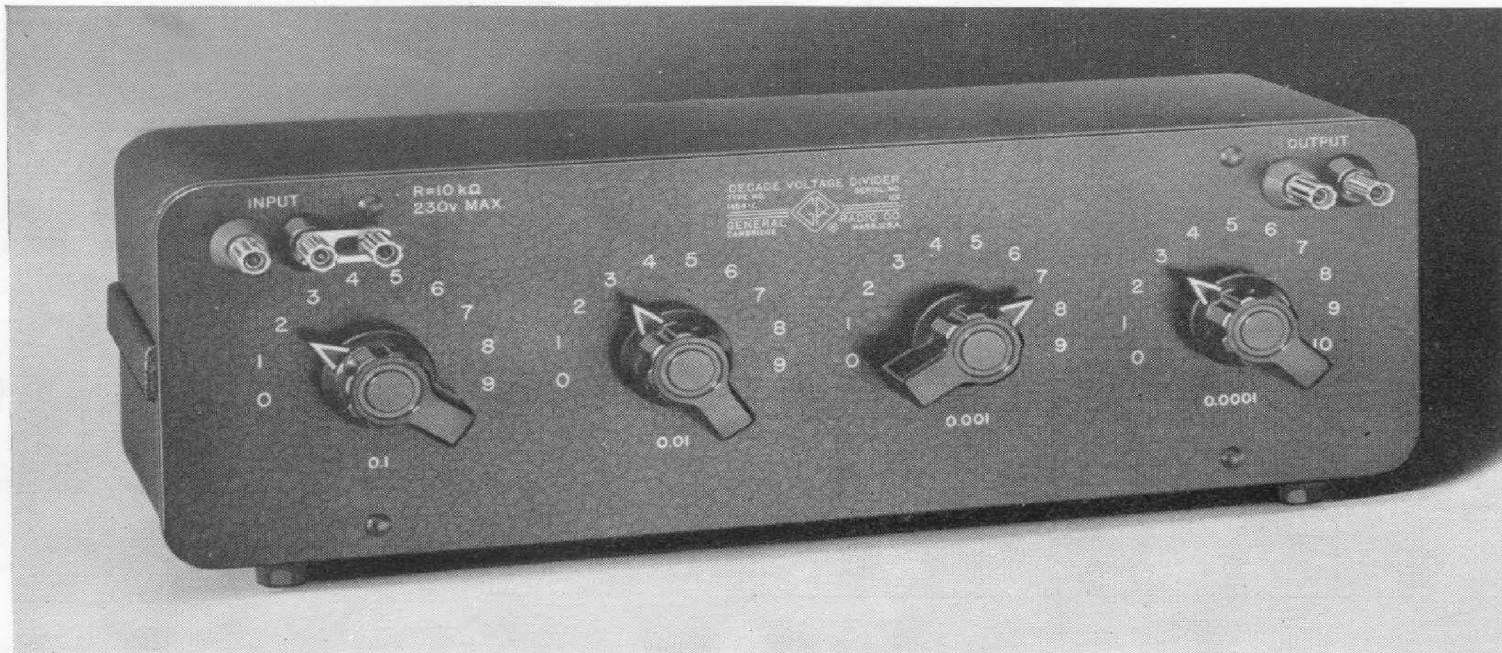

decade. The next decade has resistors one-fifth the resistance of the first and bridges any pair of resistors of the first decade. Across the second decade is placed, therefore, one-tenth the potential of the input, and this increment may be chosen as any one of ten equal increments between zero and full voltage on the first decade. In a similar manner, the third decade has units one-fifth the value of the second and is bridged across two resistors of the eleven in the second decade. The fourth decade is a conventional ten-step voltage divider.

The construction of the TYPE 1454-A is very similar to that of the TYPE 1432<sup>1</sup> Decade Resistors except that the switching operation requires two switch arms insulated from each other. Both input and output terminals are insulated from ground, and a separate ground binding post is provided. The divider may thus be used in either a grounded or an ungrounded circuit, with the metal case usable as a grounded shield for either method of connection.

**Accuracy Considerations**

With fixed precision resistors in this voltage-divider circuit, extremely high accuracy of voltage division is obtained. Consider a single decade. At maximum output setting the error in voltage *division* is, by definition, *zero*. The possi-

<sup>1</sup>Easton, I. G.. "The New TYPE 1432 Decade Resistors," General Radio Experimenter, Vol. XXVI, No. 1, June, 1951.

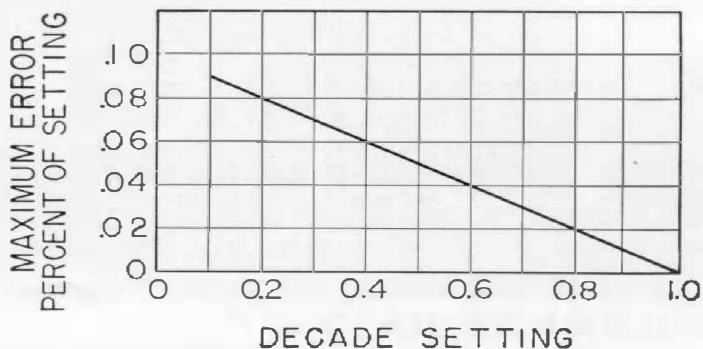
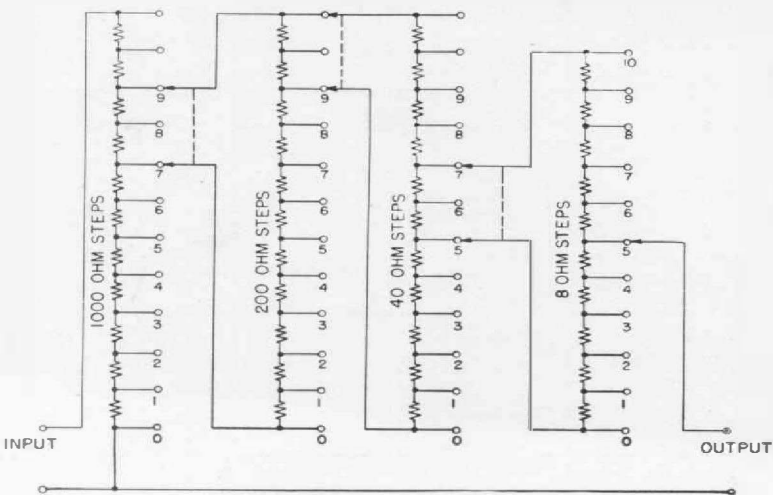

**Figure 3. Maximum error as a function of scale setting.**

ble error in division for a given setting, expressed as a percentage of that setting, increases as the setting is decreased. Figure 3 shows the linear nature of the variation of maximum error as a function of setting. Since the resistors are accurate to 0.05%, the maximum error is .09% at 0.1 setting. In terms of full-scale setting, which is a common method of expressing instrument errors and voltage-divider errors, the maximum error that can occur is ±.025%. This error can occur at mid-point, and the variation with setting is shown in Figure 4.

The values of Figure 3 and Figure 4, although indeed gratifyingly low, are very conservative. Whether the errors in adjustment of the values of the individual resistors are random or systematic, the error in voltage division will rarely approach the maximum figures cited. The fact that the division ratio depends on a large number of resistors reduces the error, on a statistical basis, when *random* errors of adjustment are considered. If *systematic* errors occur, their effects are greatly reduced in taking the ratio of two sets of resistance values. Consequently, actual errors will rarely exceed one-half the values indicated by Figures 3 and 4.

**Figure 2. Schematic diagram showing the method of voltage division.**

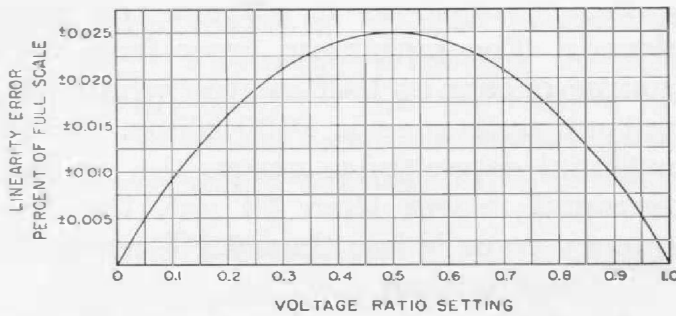

Figure 4. Maximum error in per cent of full-scale maximum setting.

### Effect of Zero Resistance

With all decades set to zero, the output voltage of the divider should ideally be zero. Actually there will be some output caused by current flowing through the resistance of the wiring and the contact resistances at the switches, which are in series in the output circuit. Analysis of the circuit shows that the total voltage developed in the output circuit, for a four-dial divider, set at

zero, is  $E \left( \frac{7}{8} \right) \frac{R_c}{R_o}$  where  $E$  is the im-

pressed input voltage,  $R_o$  the input resistance of the divider and  $R_c$  the contact and wiring resistance that may exist between the zero points of the successive switches. With the input resistance at 10,000 ohms and the zero resistance of the order of a few milliohms, it is clear that the residual output voltage, although less than a microvolt per volt of input, impairs the absolute accuracy of the smallest output step.

When the divider is used for d-c voltage division, potentials caused by thermo-electric<sup>2</sup> forces, contact potentials, electrolytic action, and the like can cause additional small errors. Conservative allowance for all these effects

is made by including in the accuracy statement a fixed error of  $\pm .000001$  in ratio which is equivalent to  $\pm 1$  microvolt per volt of input.

### Output Resistance

The decimal voltage division is the ratio of the open-circuit output voltage to the voltage impressed on input terminals, and the voltage divider is primarily intended for use with high impedance loads, as, for example, in null circuits where no current is drawn. For loads of finite impedance, it is necessary to know accurately the effective output impedance of the divider in order to calculate the actual voltage on the load, or to know the impedance approximately in order to estimate the reduction in voltage. To determine the output resistance of the resistive divider, it is helpful to consider first the output resistance of a simple divider system, as shown in Figure 5.

Analysis of the multiple-decade circuit of Figure 2 shows that the output resistance is the sum of the equivalent output resistances of the individual decades. For the purpose of the equivalent circuit of Figure 6, the potential of each decade must be taken as the sum of its setting plus that of the succeeding decades. This is best illustrated by a specific numerical example. Suppose the TYPE 1454-A (a 10,000-ohm divider) is set at .2373. The first resistor in the equivalent circuit is the output resistor of a simple 10,000-ohm divider set at .2373, the second resistance is that of a 1000-ohm divider set at .373, the third that of a 200-ohm divider set at .73 and finally a 40-ohm divider set at .3.

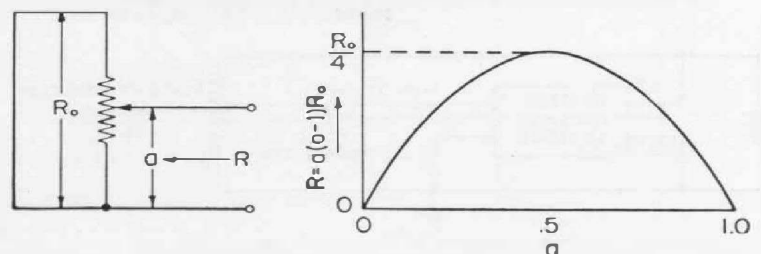

<sup>2</sup> All resistors are wound with resistance alloys having low thermal emf to copper.

Figure 5. Output resistance characteristic of a simple voltage divider.

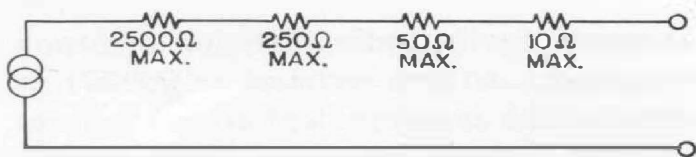

Figure 6. Equivalent circuit of a four-decade divider.

The corresponding resistances are 1809.9, 233.9, 39.4, and 8.4 or a total of 2091.6 ohms. The output voltage, of course, is .2373 times the input voltage. This calculation is cumbersome and, for estimating the approximate impedance, linear interpolation between points in Table I is usually adequate.

TABLE I

	.00	.01	.02	.03	.04	.05	.06	.07	.08	.09
0	0	189	356	501	624	725	804	861	896	909
.1	900	1069	1216	1341	1444	1525	1584	1621	1636	1629
.2	1600	1749	1876	1981	2064	2125	2164	2181	2176	2149
.3	2100	2229	2336	2421	2484	2525	2544	2541	2516	2469
.4	2400	2509	2596	2661	2704	2725	2724	2701	2656	2589
.5	2500	2589	2656	2701	2724	2725	2704	2661	2596	2509
.6	2400	2469	2516	2541	2544	2525	2784	2421	2336	2229
.7	2100	2149	2176	2181	2164	2125	2064	1981	1876	1749
.8	1600	1629	1636	1621	1584	1525	1444	1341	2116	1069
.9	900	909	896	861	804	725	624	501	356	189

**Frequency Response**

No independent absolute method of checking the a-c response of a highly accurate divider such as the TYPE 1454-A is available. The performance can be deduced, however, from calculations based on the known parameters of the system and checked by measurements at frequencies sufficiently high to magnify the errors that occur.

The resistors have in themselves extremely low residual inductance and capacitance, and it can be shown that the significant factor in a-c performance is the shunt capacitance of wiring and

switch frames as it affects the first decade. The maximum error from this source occurs at half setting where the output resistance is 2500 ohms. If the external capacitance across the output terminal is less than 50  $\mu\mu\text{f}$ , the frequency error is less than 0.1% up to 20 kc at any setting.

At settings approaching zero, the inductance of the wiring introduces an error of the same nature as previously described for zero resistance. The total output loop inductance is approximately 0.7  $\mu\text{h}$ . At 10 kilocycles, this produces an output voltage at zero setting equal to one microvolt per volt of input. This error increases directly with frequency.

**USES**

The high accuracy as detailed above makes the TYPE 1454-A Decade Voltage Divider useful for a wide variety of laboratory measurements. A number of suggested applications are outlined herewith.

**Calibration of Vacuum-Tube Voltmeters**

The simple circuit shown in Figure 8 has been adopted in the Engineering Labs at General Radio for the periodic checking of all a-c and d-c vacuum-tube voltmeters. The standard meter is relied upon for only a calibration value near its full-scale reading, where best accuracy is obtained.

**D-C Null Method for Linearity Checking**

A voltage comparison method is widely used for checking the linearity of wire-wound potentiometers. A simple

Figure 7. Voltage divider in null circuit for linearity tests.

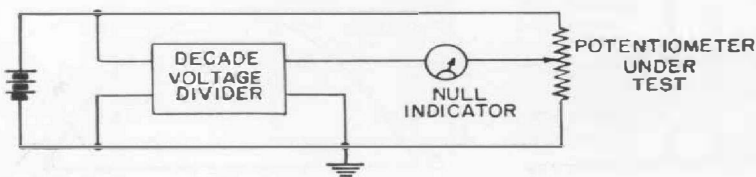
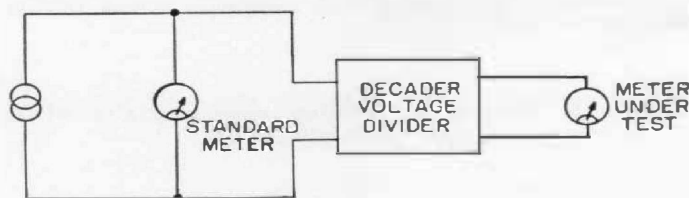

Figure 8. Circuit for calibration and test of vacuum-tube voltmeters.





schematic diagram of the method is shown in Figure 7. With the voltage divider adjusted for null indication, no current is drawn from the divider, and the open-circuit calibration is correct.

### A-C Null Method

The null method of Figure 7 is equally applicable at power and audio frequencies although capacitive loading must be watched as a possible source of error. Even when the system is balanced to a null, current is still drawn by the ground capacitance of the null detector. By the use of shielding (for example, by using a TYPE 578 transformer), the location of the ground capacitance can be controlled and placed where it will be least harmful. In general, if the device under test has an impedance greater than 2500 ohms (the maximum output impedance of the voltage divider), the shielding should be arranged to place the ground capacitance across the divider output. On the other hand, if the device under test is low compared to 2500 ohms, less

error will be introduced by shunting the capacitance across the output of the device.

### Ungrounded Measurements

Greatest immunity from the effects of stray capacitance, both external to and within the divider, is obtained by operating ungrounded. This requires the use of shielded transformers both at input and at the null detector.

Generally speaking, at the very important frequencies of 400 and 1000 cycles, no difficulty should be encountered from stray capacitance if reasonable precautions are taken, and the accuracy of measurement be taken as the d-c accuracy.

### Gain-Loss Measurements

Other important uses include the measurement of gain or loss in amplifiers, attenuators, filters, and other networks; and the determination of turns ratio in transformers.

— IVAN G. EASTON

## SPECIFICATIONS

**Voltage Ratio:** .0001 to 1.0000 in steps of .000100.

**Accuracy:**  $\pm (0.1\% + .000001)$ . All resistors are adjusted to within  $\pm 0.05\%$  of nominal values. The voltage ratio error will rarely exceed this figure, although at low settings of each decade, the error can theoretically approach  $\pm 0.1\%$ .

**Frequency Characteristics:** If the external capacitance placed across the output terminals is less than 50  $\mu\mu\text{f}$ , the frequency error is less than 0.1% to 20 kc for any setting.

**Input Impedance:** 10,000 ohms. This value is engraved on the panel.

**Output Impedance:** Varies with output setting, depending primarily on the setting of the highest decade in use.

**Maximum Input Voltage:** 230 volts rms (or dc) for 40° Centigrade rise of resistors in the input decade. This value is engraved on the panel.

**Resistance Units:** Similar to TYPE 510. Unifilar on mica for two decades. Third and fourth decades are Ayrton-Perry on phenolic cards.

**Temperature Coefficient:** Of the individual resistors, less than  $+0.002\%$  per degree Centigrade. Since the voltage ratio is determined by the ratio of resistors of similar construction, the temperature coefficient of the voltage ratio is, for practical purposes, very nearly zero at normal room ambient temperatures and within the power rating of the box.

**Terminals:** Jack top binding posts with standard  $\frac{3}{4}$ -inch spacing at input and output. A separate ground post is provided, so that the divider circuit can be used grounded or ungrounded, with the shield grounded.

**Mounting:** Aluminum panel and cabinet.

**Dimensions:** (Length)  $15\frac{3}{4}$  x (width)  $5\frac{1}{4}$  x (height) 5 inches, over-all.

**Net Weight:**  $7\frac{1}{4}$  pounds.

Type		Code Word	Price
1454-A	Decade Voltage Divider .....	ABACK	\$135.00

# NEW COAXIAL ELEMENTS

The widespread use of u-h-f instruments and components based on the GR TYPE 874 Coaxial Connector is constantly bringing to light the need for additional components to extend the

scope of measurements. A continuous development program already has produced many new items, and several more are under development. Latest additions to the line are described here.

## COAXIAL STANDARDS

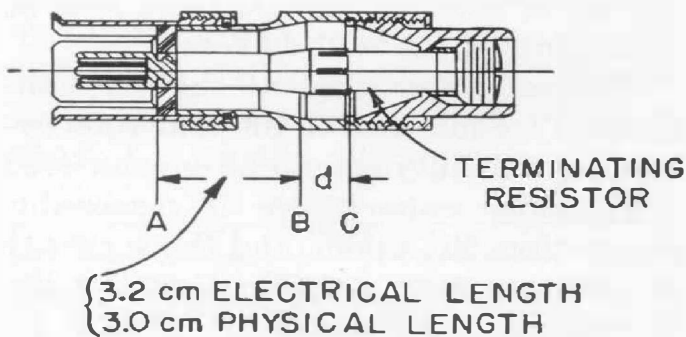

Figure 1. Cross sectional view of Types 874-W100 and W200 Coaxial Standards. The effective position of the pure resistance termination is at C. Type 874-WN and WO Short and Open-Circuit Termination Units effectively terminate a line at A and Type 874-WN3 and WO3 3cm Short and Open-Circuit Termination Units effectively termi-

The new TYPE 874-W100 and TYPE 874-W200 Terminations produce known resistive terminations at specific locations on coaxial lines. They are very useful in testing the operation of measuring circuits, as, for instance, in checking the linearity of the detector in a slotted line and the accuracy of measurements made with directional couplers, bridges, and admittance meters. Figures 2a and 2b show the VSWR of each unit as a function of frequency, as well as the location of the resistive termination with respect to a known point in the connector. The known location of the pure resistive termination makes possible the production of many known complex impedances through the addition of sections of TYPE 874-L Air Line.

nate a line 3 cm from the front face of the insulator at B. The distance between B and C, labeled d, is plotted in Figures 2a and 2b as a function of frequency.

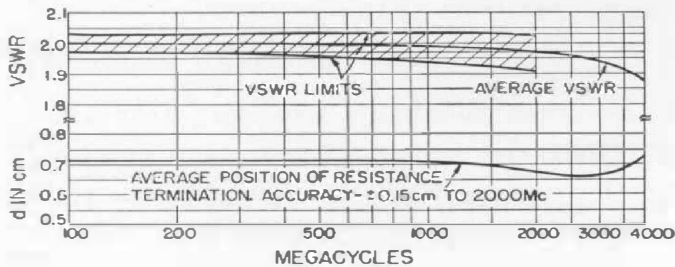
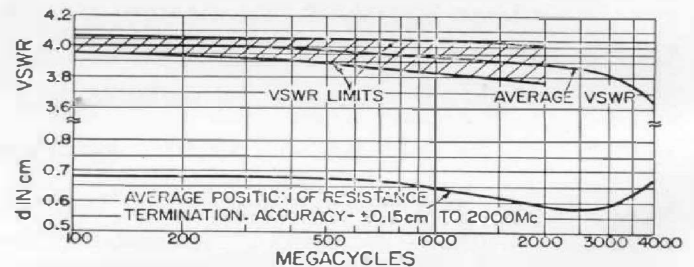

Figure 2a. Plot of the VSWR and position of the pure resistance termination, for a Type 874-W100 100-Ohm Coaxial Standard. The distance, d, is the distance from the position of the short or open circuit produced by a Type WN3 or WO3 Termination Unit to the position of the pure re-



sistance termination as indicated in Figure 1. The cross-lined area indicates the tolerances on the characteristics.

Figure 2b. Plot of the characteristics of a Type 874-W200 200-Ohm Coaxial Standard.

TYPE 874-W100 100-Ohm Coaxial Standard  
**D-C Resistance:** 100 ohms  $\pm 1\%$   
**Maximum Power:**  $\frac{1}{3}$  watt  
**Net Weight:** 3 ounces

TYPE 874-W200 200-Ohm Coaxial Standard  
**D-C Resistance:** 200 ohms  $\pm 1\%$   
**Maximum Power:**  $\frac{1}{4}$  watt  
**Net Weight:** 3 ounces

Type		Code Word	Price
874-W100	100-Ohm Coaxial Standard.....	COAXCENTER	\$12.50
874-W200	200-Ohm Coaxial Standard.....	COAXILTER	12.50

## BALUN ACCESSORIES

### 200-Ohm Terminal Unit

The TYPE 874-UB Balun is used to connect balanced circuits to unbalanced coaxial circuits

and vice versa. It operates as a 4:1 impedance transformer; a 50-ohm coaxial system appears as 200-ohms at the balanced terminals. The



balanced termination supplied with the balun was designed for the commonly used 300-ohm balanced transmission line. However, in cases in which the balun is used with a coaxial measuring device for measurements of the actual complex impedance of a balanced network rather than the VSWR on a 300-ohm line, the use of a 200-ohm balanced line and a balun terminal unit can greatly simplify the procedure. The 4:1 impedance transformation produces a 50-ohm grounded impedance, and therefore the 200-ohm balanced line can be treated as an extension of the 50-ohm line in the measuring device. A suitable line for this purpose is the TYPE RG-86/U, and the new TYPE 874-UB-P2 Balun Terminal Unit (200 ohms) has been designed to connect to it.

**Characteristic Impedance:** 200 ohms.  
**Frequency Range:** 0 to 1000 Mc.  
**Recommended Transmission line:** RG-86/U.  
**Net Weight:** One ounce.

**300-Ohm Terminal Pad**

It is often necessary to obtain a 300-ohm balanced source when available generators have 50-ohm coaxial outputs. The TYPE 874-UB-P3 300-ohm Balun Terminal Pad converts to 300 ohms the 200-ohm balanced output impedance produced from a 50-ohm unbalanced source by the TYPE 874-UB Balun. This unit contains a built-in 50-ohm resistor in series with each balanced lead. The same arrangement can be used to terminate a 300-ohm balanced line in 300-ohms if the coaxial connector on the balun is connected to a matched TYPE 874-WM 50-Ohm Termination Unit or to a matched detector. Figure 4 shows the VSWR of such a load over a wide frequency range.

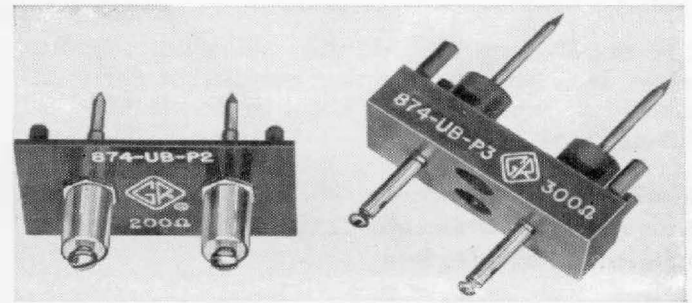

**Figure 3. Type 874-UB-P2 Balun Terminal Unit (200 ohms) and the Type 874-UB-P3 300-Ohm Balun Terminal Pad.**

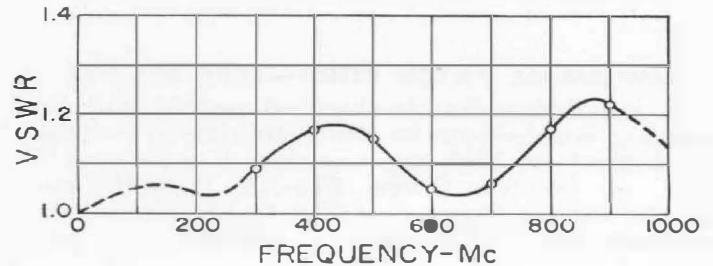

**Figure 4. Plot of the VSWR at the 300-ohm terminals of a typical Type 874-UB-P3 Terminal Pad as a function of frequency when the pad is inserted in a properly adjusted balun whose coaxial circuit is terminated in 50 ohms.**

**Frequency Range:** 0 to 1000 Mc.  
**Input or Output VSWR:** When coaxial line is terminated in 50 ohms, VSWR at 300-ohm balanced terminals is less than 1.2 up to 300 Mc. and less than 1.3 up to 1000 Mc.  
**Net Weight:** 2 ounces.

Type		Code Word	Price
874-UB-P2	Balun Terminal Unit (200 ohms).....	COAXTERMER	\$5.00
874-UB-P3	300-Ohm Balun Terminal Pad .....	COAXTUGGER	9.00

**300-OHM BALANCED TERMINATION**

One very useful element for balanced-line measurements is a simple 300-ohm termination. The TYPE 874-BM 300-ohm Balanced Termination shown in Figure 5 is such a device which has a VSWR of less than 1.2 at frequencies up to 900 Mc. The VSWR of a typical unit is shown in Figure 6.

**Frequency Range:** 0 to 1000 Mc.  
**D-C Resistance:** 300 ohms  $\pm$  5%.  
**Net Weight:** 1 1/2 ounces.  
**VSWR:** Less than 1.2 from d-c to 900 Mc.

Type		Code Word	Price
874-BM	300-Ohm Balanced Termination.....	COAXLOADER	\$5.00

**Figure 5. Type 874-BM 300-Ohm Balanced Termination Unit.**



**Figure 6. A plot of the VSWR as a function of frequency of a typical Type 874-BM 300-Ohm Balanced Termination Unit.**

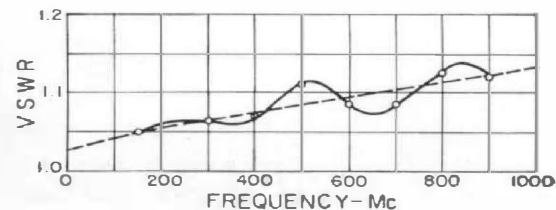



874-A3 COAXIAL CABLE

A small-diameter, double shielded, 50-ohm cable. Has stranded center conductor for good flexibility and long life. Used in TYPE 874-R22 Patch Cord.

**Center Conductor:** 19 strands of 0.0066 inch, tinned soft copper wire.

**Outer Conductor:** Double braid.

**Jacket:** Polyvinyl chloride, diameter .206".

**Nominal Attenuation:** 5.3 db/100 feet at 100 Mc.  
22.0 db/100 feet at 1000 Mc.

45.0 db/100 feet at 3000 Mc.

**Characteristic Impedance:** 50.0 ohms  $\pm$  5%.

**Diameter Over Dielectric:** .116".

**Dielectric:** Polyethylene.

Type		Code Word	Price
874-A3	Coaxial Cable.....	COAXGABBER	\$0.35/foot 0.20/foot for 25 feet or more

NEW SMALL PATCH CORD—TYPE 874-R22

A small-size double-shielded patch cord for making connections in which minimum leakage is desired at high frequencies. Consists of 3 feet of 50-ohm TYPE 874-A3 Polyethylene Cable with a TYPE 874-C58 Cable Connector on each end. Net Weight: 4 ounces.

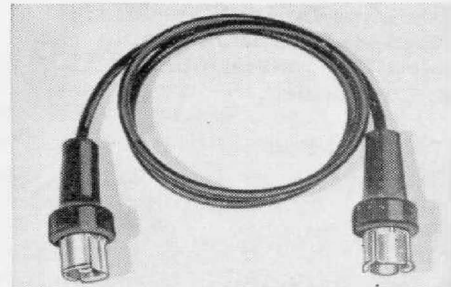

Figure 7. Type 874-R22 Patch Cord.

Type		Code Word	Price
874-R22	Patch Cord.....	COAXFANNER	\$6.00

Two new rigid-line adaptors, panel connectors, and cable connectors will be described in the September *Experimenter*.

**CORRECTION—July, 1955 issue, page 14.**  
The maximum pulse durations listed in section (4) of the output pulse specifications should all be in milliseconds and not milli-microseconds.

# GENERAL RADIO COMPANY

275 MASSACHUSETTS AVENUE  
CAMBRIDGE 39 MASSACHUSETTS  
TELEPHONE: Trowbridge 6-4400

## BRANCH ENGINEERING OFFICES

NEW YORK 6, NEW YORK  
90 WEST STREET  
TEL.—Worth 4-2722

LOS ANGELES 38, CALIFORNIA  
1000 NORTH SEWARD STREET  
TEL.—Hollywood 9-6201

CHICAGO 5, ILLINOIS  
920 SOUTH MICHIGAN AVENUE  
TEL.—WAbash 2-3820

SILVER SPRING, MARYLAND  
8055 13TH STREET  
TEL.—JUniper 5-1088

PHILADELPHIA OFFICE  
1150 YORK ROAD  
ABINGTON, PENNSYLVANIA  
TEL.—HAncock 4-7419

## REPAIR SERVICES

WEST COAST  
WESTERN INSTRUMENT CO.  
826 NORTH VICTORY BOULEVARD  
BURBANK, CALIFORNIA  
TEL.—VICTORIA 9-3013

CANADA  
BAYLY ENGINEERING, LTD  
FIRST STREET  
AJAX, ONTARIO  
TEL.—Toronto EMpire 8-6866

PRINTED  
IN  
U.S.A.